

Enhancing Timing Accuracy in Air Shower Radio Detectors

E.T. de Boone¹

Supervisor: dr. Harm Schoorlemmer



July, 2023

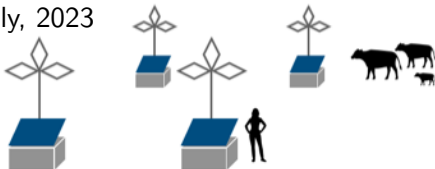

¹e-mail: erichteunis@deboone.nl

Ultra High Energy particles

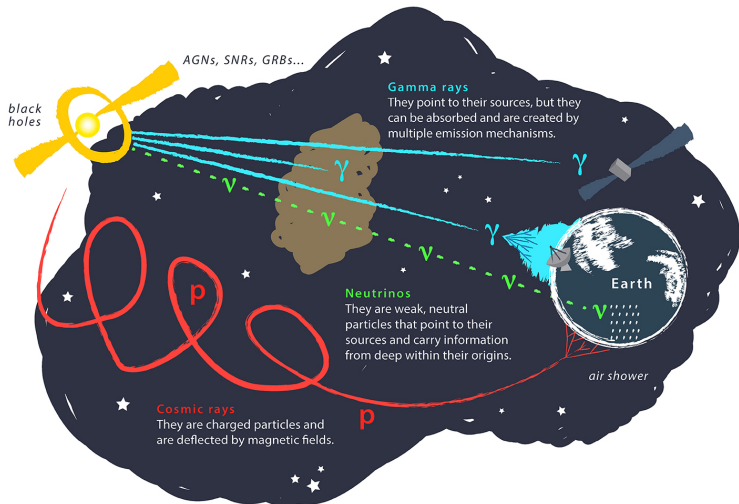

Credit: Juan Antonio Aguilar and Jamie Yang. IceCube/WIPAC

Ultra High Energy particle flux

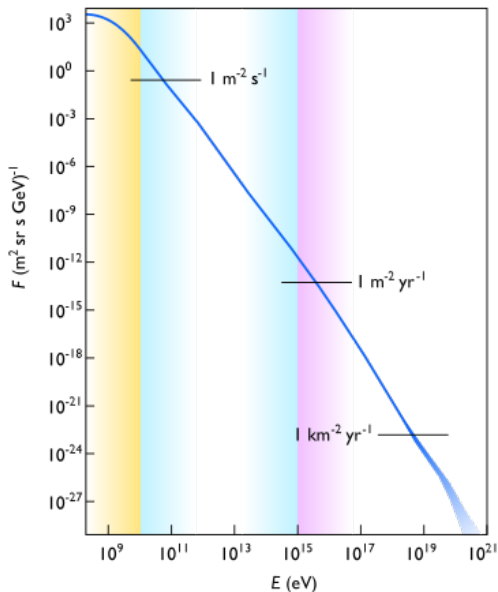

Credit: Particle Data Group

Cosmic Particles Detection

Large Area Experiments:

- ▶ Pierre Auger Observatory
- ▶ Giant Radio Array for Neutrino Detection

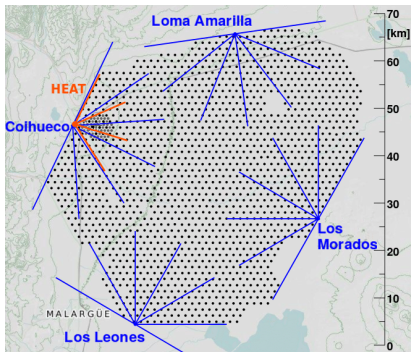

Credit: Hans O. Klages

Air Showers

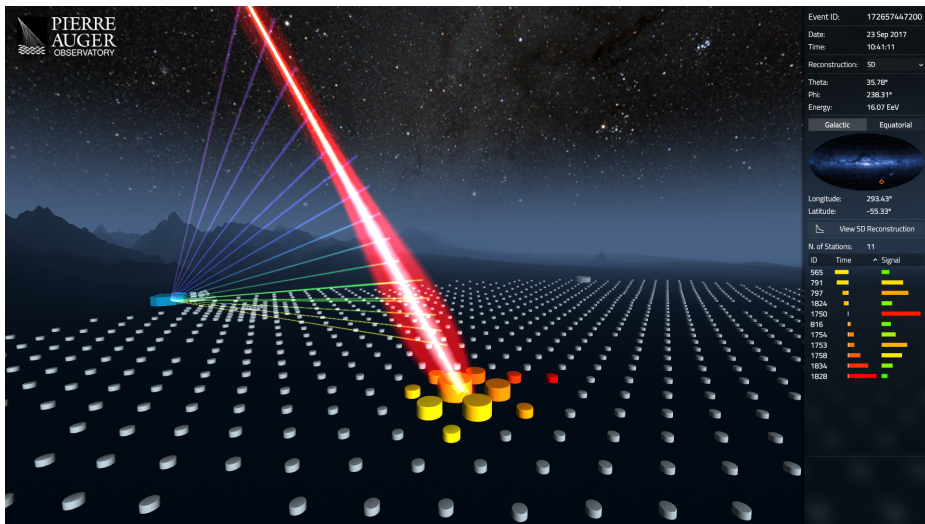

From: <https://opendata.auger.org/display.php?evid=172657447200>

Air Shower Radio Emission

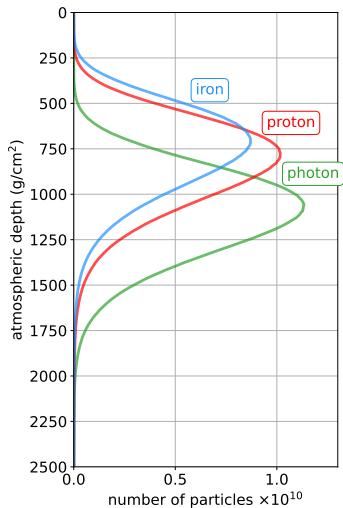

Credit: H. Schoorlemmer

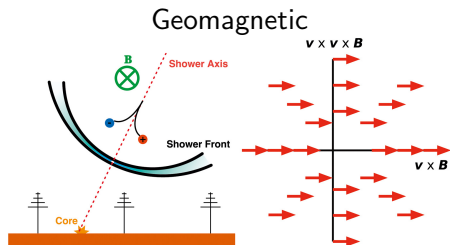
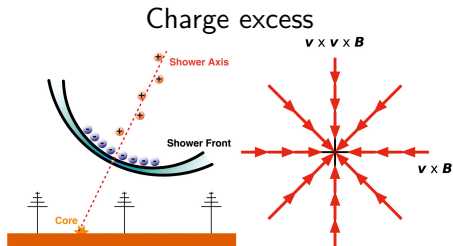

[5]. arXiv: 1701.02995

Radio Interferometry: Concept

Interferometry: Amplitude + Timing information of the \vec{E} -field

- ▶ Measure signal $S_i(t)$ at antenna \vec{a}_i

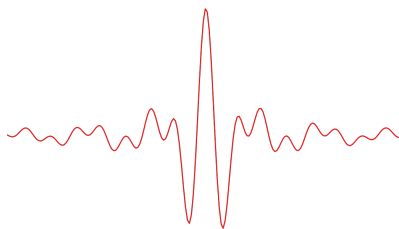
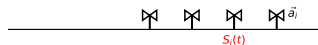

Radio Interferometry: Concept

Interferometry: Amplitude + Timing information of the \vec{E} -field

- ▶ Measure signal $S_i(t)$ at antenna \vec{a}_i
- ▶ Calculate light travel time
- ▶ Sum waveforms accounting for time delay

$$\Delta_i(\vec{x}) = \frac{|\vec{x} - \vec{a}_i|}{c} n_{eff}$$

$$S(\vec{x}, t) = \sum S_i(t + \Delta_i(\vec{x}))$$

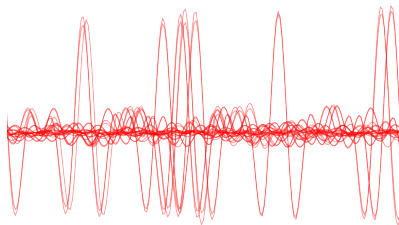
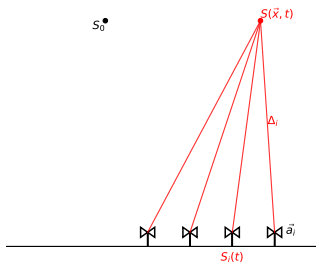

Radio Interferometry: Concept

Interferometry: Amplitude + Timing information of the \vec{E} -field

- ▶ Measure signal $S_i(t)$ at antenna \vec{a}_i
- ▶ Calculate light travel time
- ▶ Sum waveforms accounting for time delay

$$\Delta_i(\vec{x}) = \frac{|\vec{x} - \vec{a}_i|}{c} n_{eff}$$

$$S(\vec{x}, t) = \sum S_i(t + \Delta_i(\vec{x}))$$

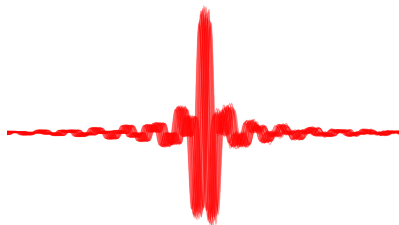
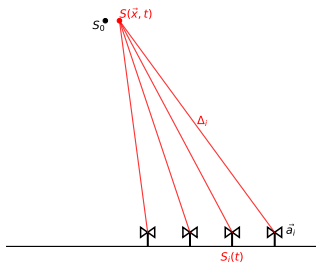

Radio Interferometry: Concept

Interferometry: Amplitude + Timing information of the \vec{E} -field

- ▶ Measure signal $S_i(t)$ at antenna \vec{a}_i
- ▶ Calculate light travel time
- ▶ Sum waveforms accounting for time delay

$$\Delta_i(\vec{x}) = \frac{|\vec{x} - \vec{a}_i|}{c} n_{eff}$$

$$S(\vec{x}, t) = \sum S_i(t + \Delta_i(\vec{x}))$$

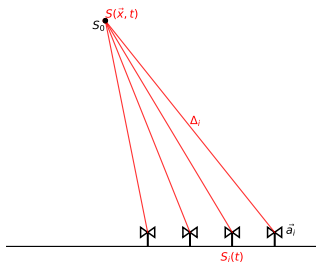

Radio Interferometry: Image

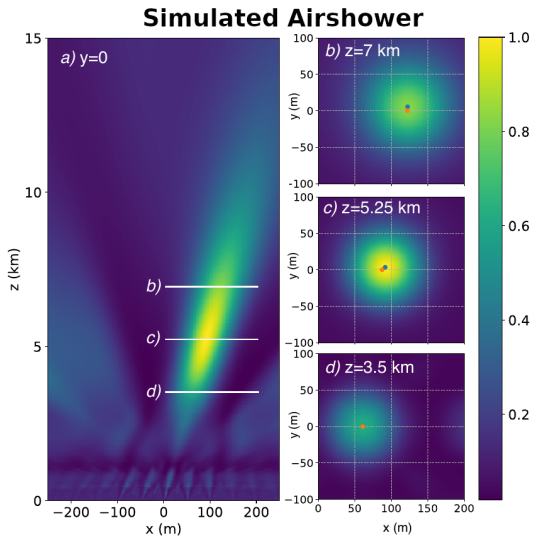

[6]. arXiv: 2006.10348

Timing in Air Shower Radio Detectors

Relative timing is important for Radio Interferometry.

(1ns @ $c \sim 30\text{cm}$)

Large inter-detector spacing ($\sim 1\text{km}$)

→ Default timing mechanism: Global Navigation Satellite Systems

What is the accuracy of such systems?

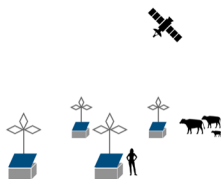

Credit: H. Schoorlemmer

Timing in Air Shower Radio Detectors

Relative timing is important for Radio Interferometry.

(1ns @ $c \sim 30\text{cm}$)

Large inter-detector spacing ($\sim 1\text{km}$)

→ Default timing mechanism: Global Navigation Satellite Systems

What is the accuracy of such systems?

@Auger: $\sigma_t \gtrsim 10\text{ns}$

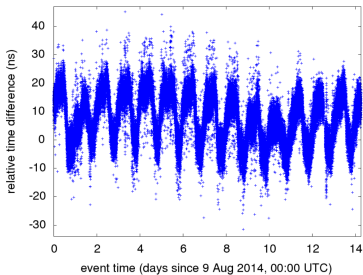

[1]. arXiv: 1512.02216

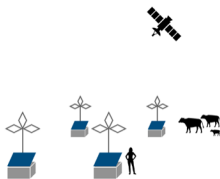

Credit: H. Schoorlemmer

Timing in Radio Detectors: Beacon Synchronisation

Relative timing is important for Radio Interferometry.

Default Timing mechanism: **Global Navigation Satellite Systems**

+Extra Timing mechanism: **Beacon** (Pulse, Sine)

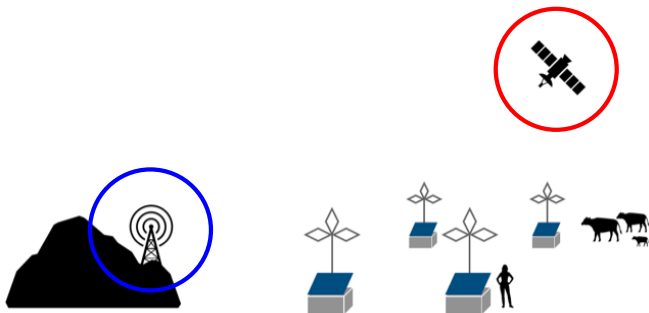

Credit: H. Schoorlemmer

Beacon Synchronisation: Geometry

Local antenna time t'_i due to time delay t_{di} , clock skew σ_i and transmitter time t_{tx}

$$t'_i = t_{tx} + t_{di} + \sigma_i$$

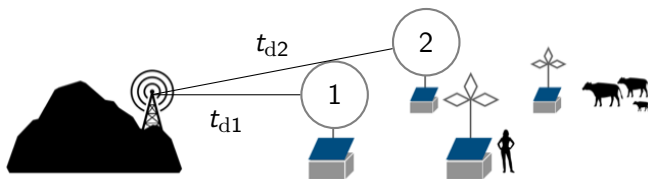

Credit: H. Schoorlemmer

Measured time difference:

$$\Delta t'_{12} = t'_1 - t'_2 = \Delta t_{d12} + \sigma_{12} + (t_{tx} - t_{tx})$$

Pulse Beacon

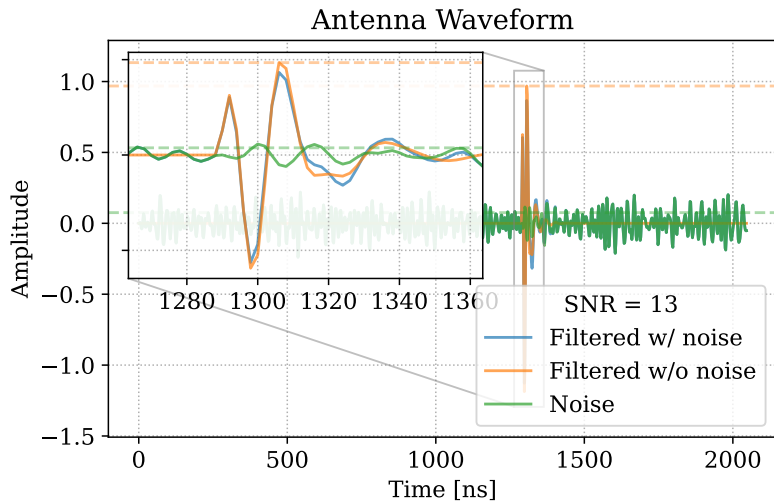

Pulse Beacon

Correlation: similarity between two signals.

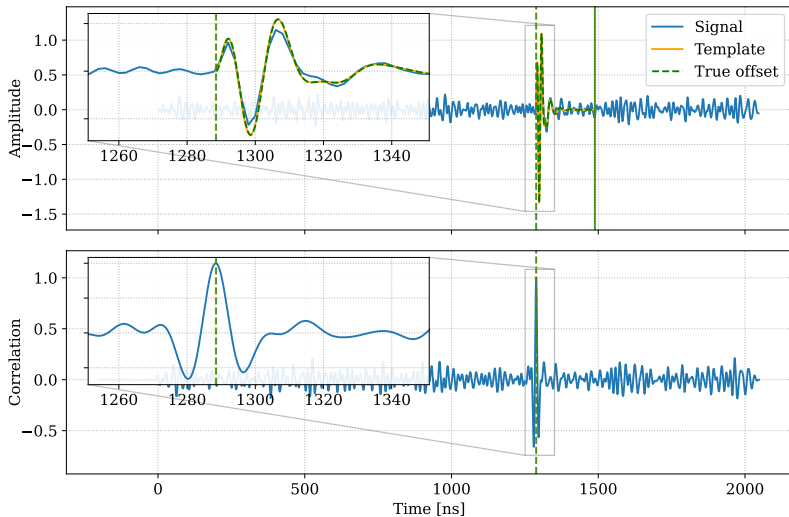

Pulse Beacon Timing

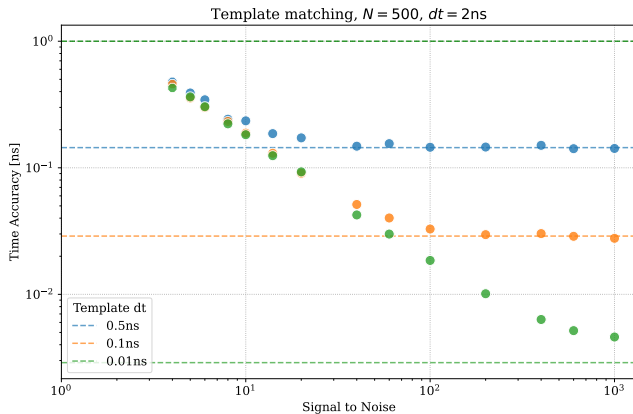

(Multi)Sine Beacon

Phase measurement φ'_i using Fourier Transform, k unknown:

$$t'_i = \left[\frac{\varphi'_i}{2\pi} + k \right] T$$

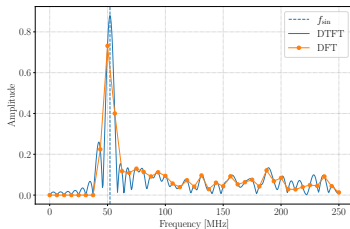
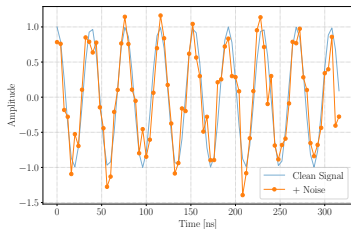

(Multi)Sine Beacon Timing

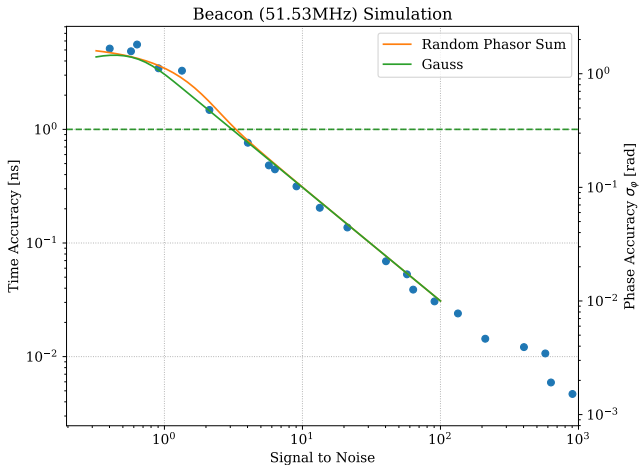

Random Phasor Sum:
 [4] "Statistical Optics", J. Goodman

$$p_\Phi(\phi; s, \sigma) = \frac{e^{-\left(\frac{s^2}{2\sigma^2}\right)}}{2\pi} + \sqrt{\frac{1}{2\pi}} \frac{s}{\sigma} e^{-\left(\frac{s^2}{2\sigma^2} \sin^2 \phi\right)} \frac{\left(1 + \operatorname{erf} \frac{s \cos \phi}{\sqrt{2}\sigma}\right)}{2} \cos \phi$$

Beacon Synchronisation: Conclusion

Pulse

- ▶ discrete
- ▶ requires template

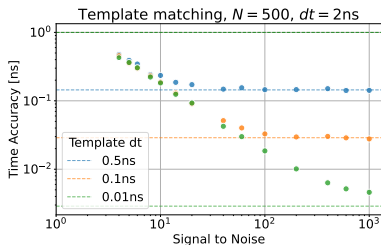

Sine

- ▶ continuous
- ▶ longer trace
↳ better SNR
- ▶ k period unknown

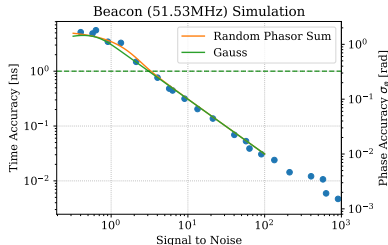

Single Sine Synchronisation

k is discrete, lift the period degeneracy using the air shower radiosignal

$$t'_i = \left(\frac{\varphi'_i}{2\pi} + n_i \right) T = A_i + B_i$$

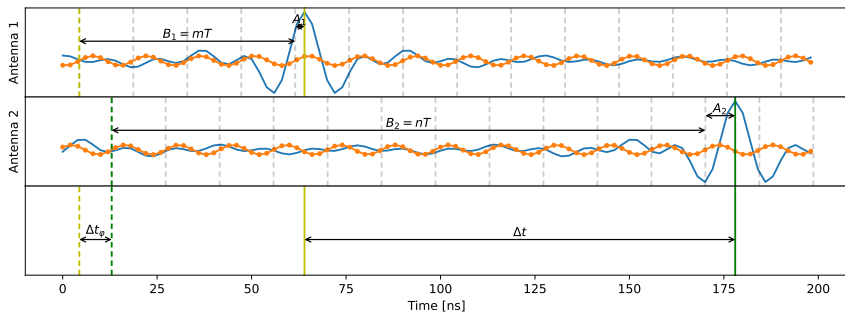

$$\begin{aligned} \Delta t'_{ij} &= (A_j + B_j) - (A_i + B_i) + \Delta t'_\varphi \\ &= \Delta A_{ij} + \Delta t'_\varphi + k_{ij} T \end{aligned}$$

Single Sine Synchronisation

k is discrete, lift the period degeneracy using the air shower radiosignal

$$t'_i = \left(\frac{\varphi'_i}{2\pi} + n_i \right) T = A_i + B_i$$

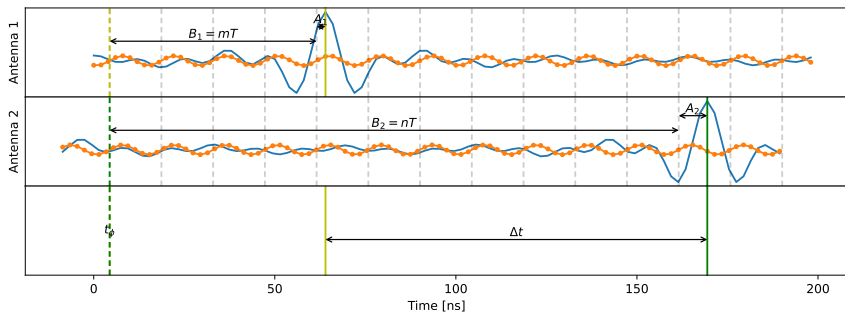

$$\begin{aligned} \Delta t'_{ij} &= (A_j + B_j) - (A_i + B_i) + \Delta t'_\varphi \\ &= \Delta A_{ij} + \cancel{\Delta t'_\varphi} + k_{ij} T \end{aligned}$$

Single Sine Synchronisation

k is discrete, lift the period degeneracy using the air shower radiosignal

$$t'_i = \left(\frac{\varphi'_i}{2\pi} + n_i \right) T = A_i + B_i$$

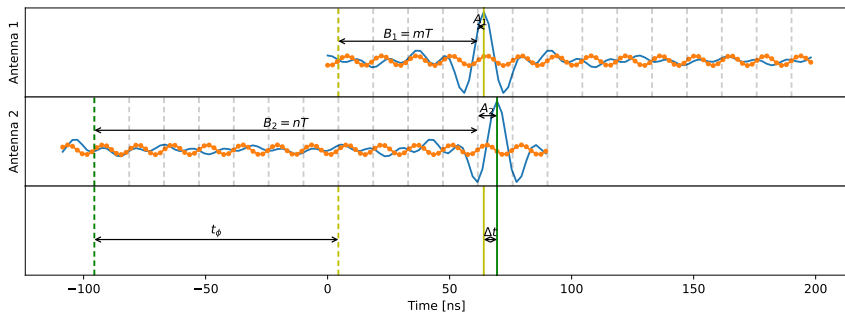

$$\begin{aligned} \Delta t'_{ij} &= (A_j + B_j) - (A_i + B_i) + \Delta t'_\varphi \\ &= \Delta A_{ij} + \Delta t'_\varphi + k_{ij} T \end{aligned}$$

Single Sine Synchronisation Simulation

Air Shower simulation on a grid of 100x100 antennas.

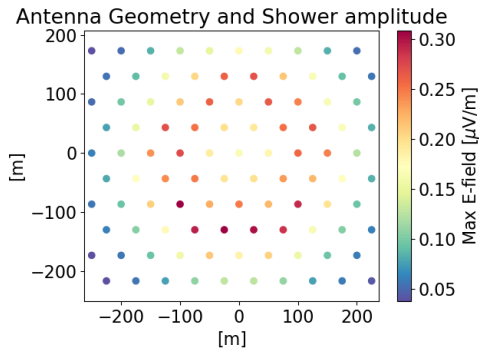

Single Sine Synchronisation Simulation

Air Shower simulation on a grid of 100x100 antennas.

- ▶ Add beacon ($T \sim 20\text{ns}$)
to antenna
- ▶ Randomise clocks
($\sigma = 30\text{ns}$)

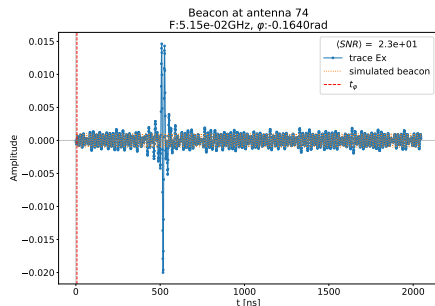

Single Sine Synchronisation Simulation

Air Shower simulation on a grid of 100x100 antennas.

- ▶ Add beacon ($T \sim 20\text{ns}$) to antenna
- ▶ Randomise clocks ($\sigma = 30\text{ns}$)
- ▶ Measure phase with DTFT
- ▶ Repair clocks for small offsets
- ▶ Iteratively find best k_{ij}

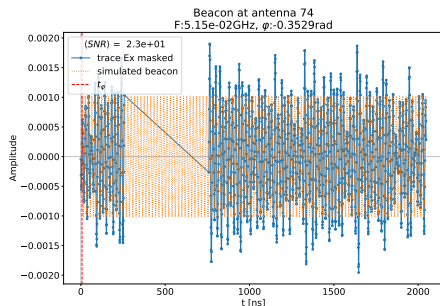

Single Sine Synchronisation: Iterative k_{0i} -finding

“Interferometry” while allowing to shift by $T = 1/f_{\text{beacon}}$

Iterative process optimizing signal power:

Scan positions finding the best $\{k_{0i}\}$ set,

then evaluate on a grid near shower axis and zoom in.

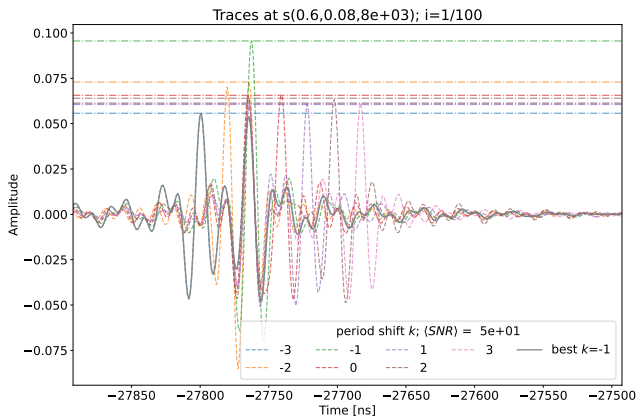

Single Sine Synchronisation: Iterative k_{0i} -finding

“Interferometry” while allowing to shift by $T = 1/f_{\text{beacon}}$

Iterative process optimizing signal power:

Scan positions finding the best $\{k_{0i}\}$ set,

then evaluate on a grid near shower axis and zoom in.

Optimizing signal strength by varying k per antenna,
Grid Run 0

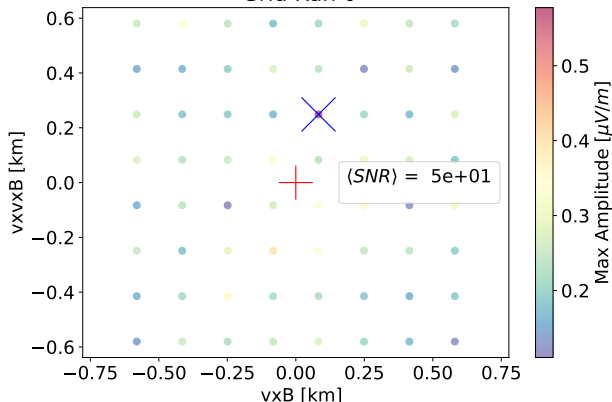

Single Sine Synchronisation: Iterative k_{0i} -finding

“Interferometry” while allowing to shift by $T = 1/f_{\text{beacon}}$

Iterative process optimizing signal power:

Scan positions finding the best $\{k_{0i}\}$ set,

then evaluate on a grid near shower axis and zoom in.

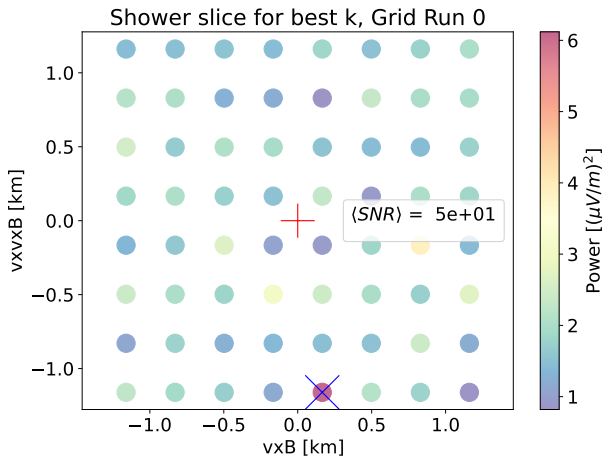

Single Sine Synchronisation: Iterative k_{0i} -finding

“Interferometry” while allowing to shift by $T = 1/f_{\text{beacon}}$

Iterative process optimizing signal power:

Scan positions finding the best $\{k_{0i}\}$ set,

then evaluate on a grid near shower axis and zoom in.

Optimizing signal strength by varying k per antenna,
Grid Run 1

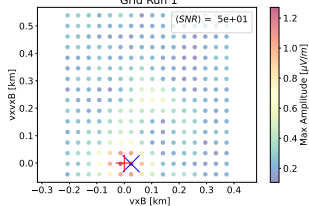

Shower slice for best k , Grid Run 1

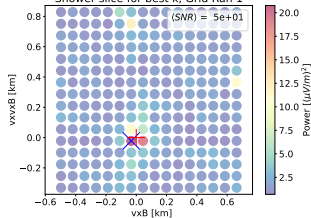

Optimizing signal strength by varying k per antenna,
Grid Run 2

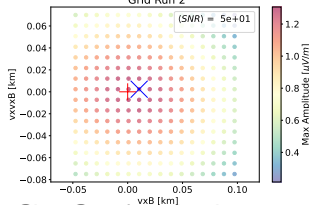

Shower slice for best k , Grid Run 2

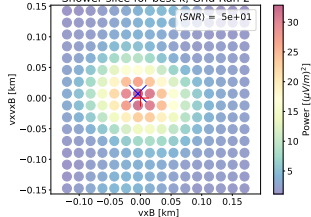

Single Sine Synchronisation: Timing Reparation

Phase reparation

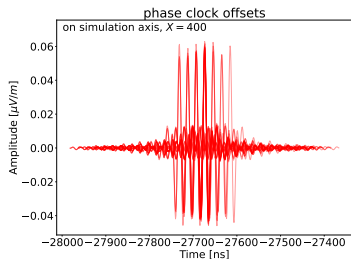

Phase + Period reparation

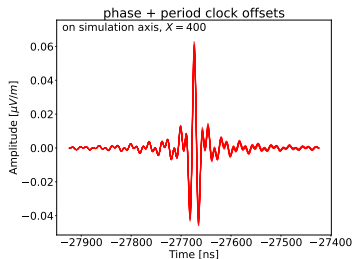

Shower plane slice
phase clock offsets
E = 0.1 PeV, $\theta = 20.0^\circ$, $\phi = 90.0^\circ$ X = 400

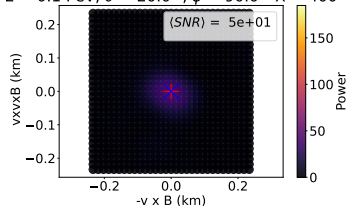

Shower plane slice
phase + period clock offsets
E = 0.1 PeV, $\theta = 20.0^\circ$, $\phi = 90.0^\circ$ X = 400

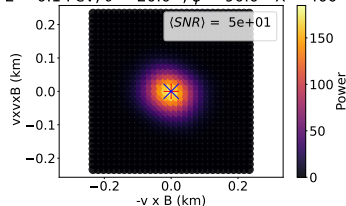

Single Sine Synchronisation: Comparison

True clock

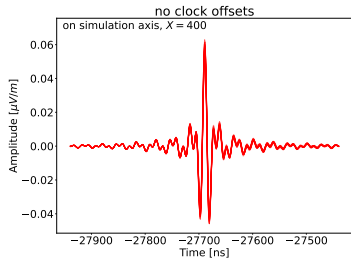

Phase + Period reparation

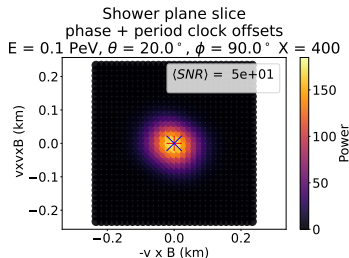
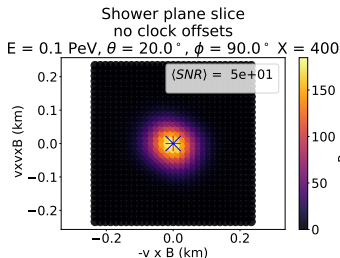
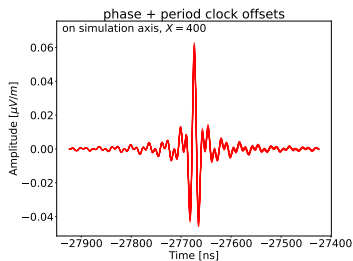

Conclusion and Outlook

- ▶ Cosmic Particles induce Extensive Air Showers
- ▶ Relative Timing is crucial to Radio Interferometry
- ▶ Pulse and Sine beacons can synchronise effectively
- ▶ Single Sine + Air Shower works

Conclusion and Outlook

- ▶ Cosmic Particles induce Extensive Air Showers
- ▶ Relative Timing is crucial to Radio Interferometry
- ▶ Pulse and Sine beacons can synchronise effectively
- ▶ Single Sine + Air Shower works

Outlook:

- ▶ Parasitic setups, i.e. the 67MHz in Auger,
- ▶ Self-calibration using pulsed beacon

Supplemental material

Table of Contents

Airshower

Radio Interferometry

Beacon contamination

Beacon Pulse

Beacon without TX

Pulse

Sine

Fourier

GNSS clock stability

In the field

White Rabbit

Single Sine Timing Result

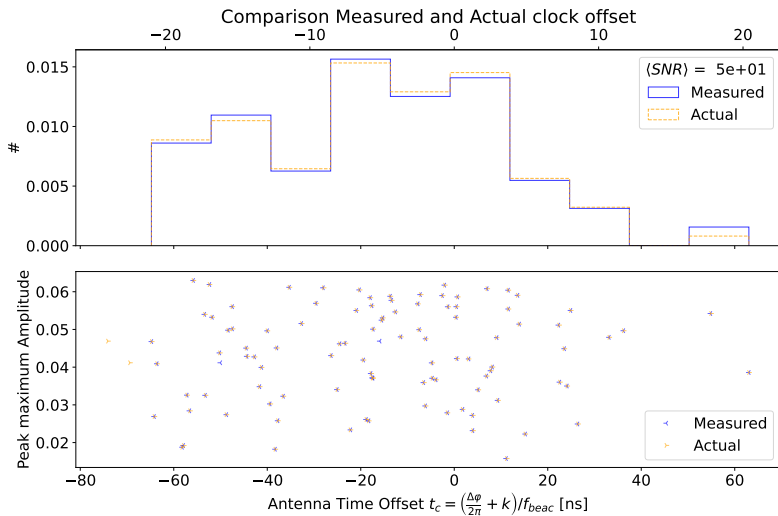

Single Sine Timing Result

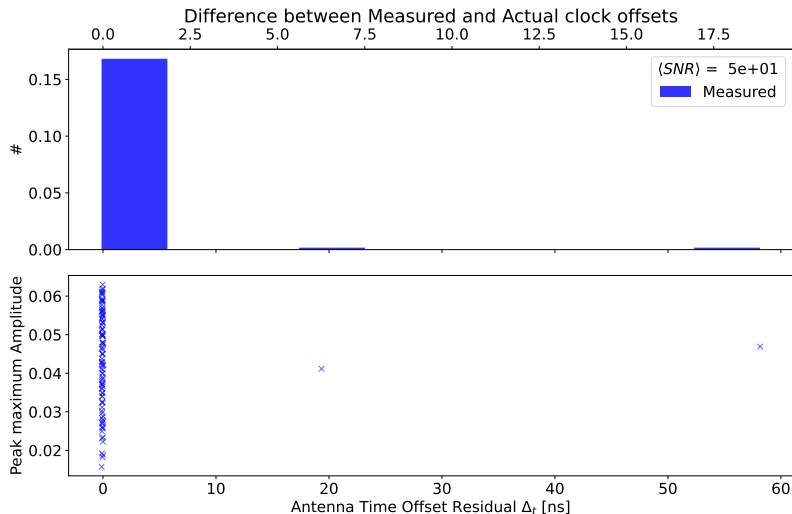

Airshower development

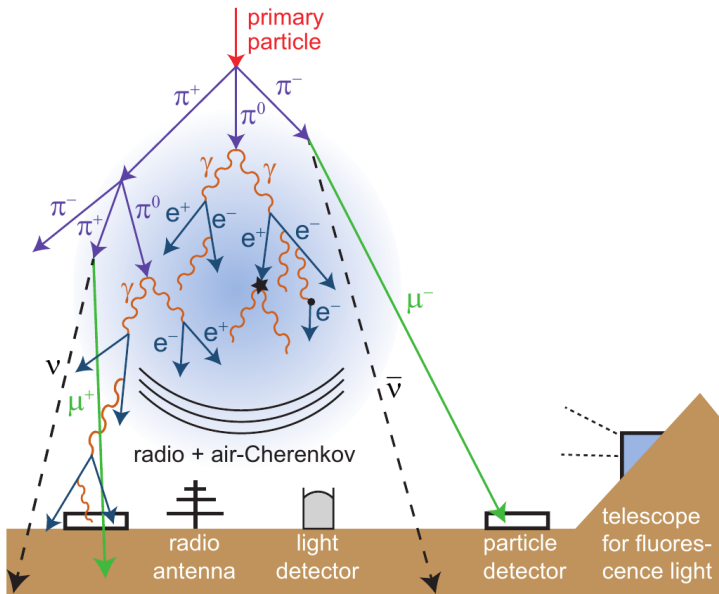

Radio footprint; GRAND

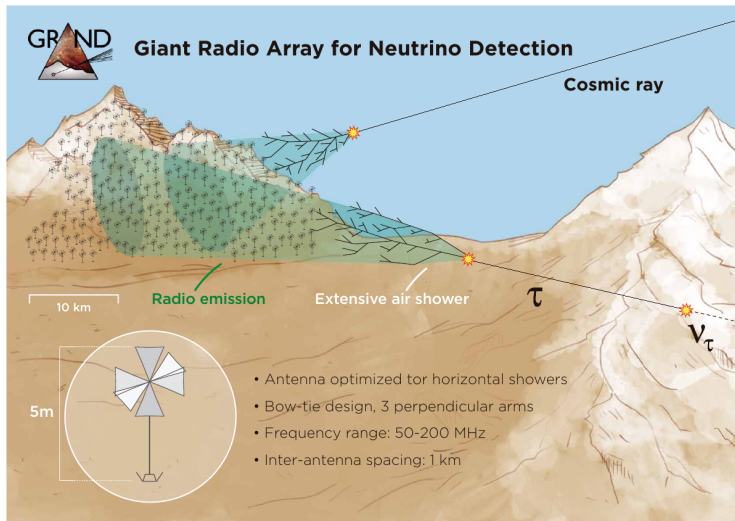

Credit: [2]. arXiv: 1810.09994

Radio Interferometry: Xmax Resolution vs Timing Resolution

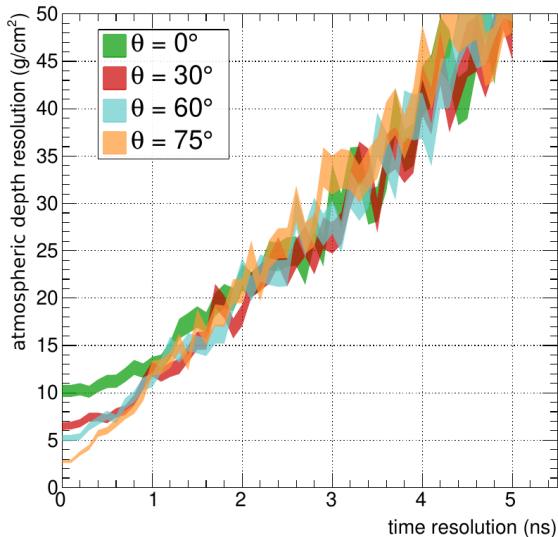

Credit: [6]. arXiv: 2006.10348

Sine: Air Shower - Beacon

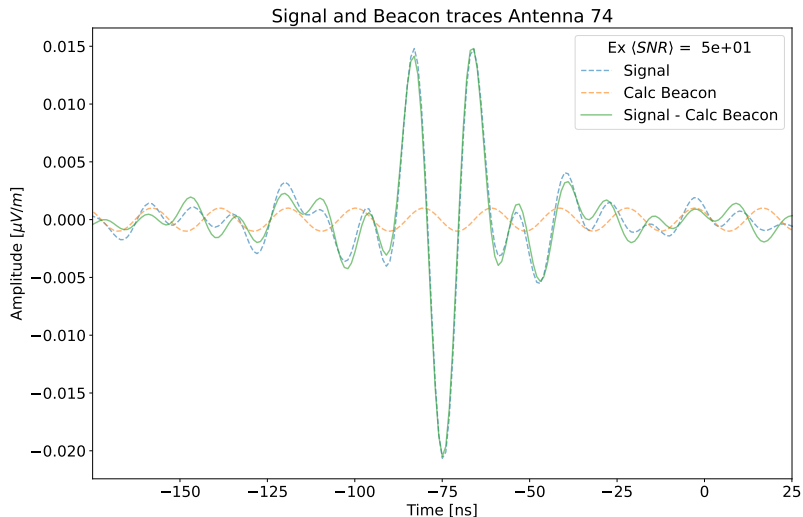

Filter Response and Sampling

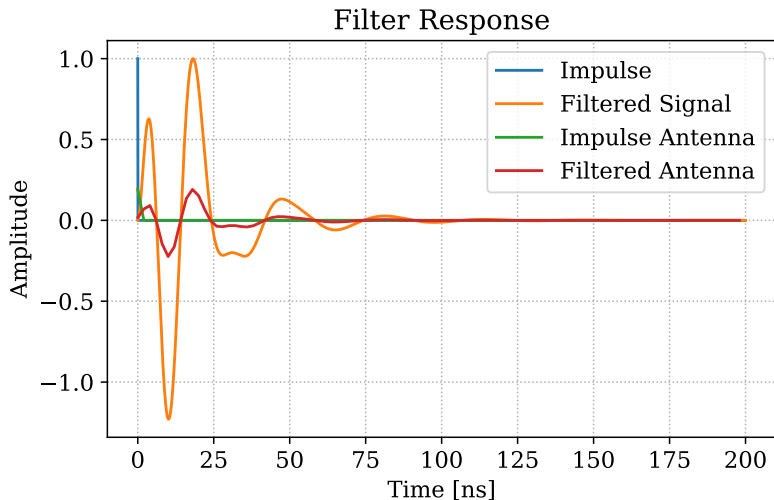

Beacon: Pulse (single baseline)

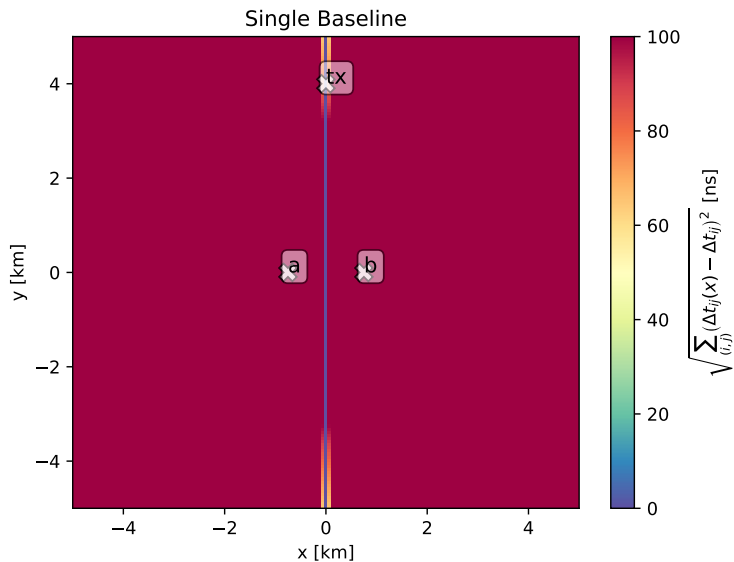

Beacon: Pulse (single baseline)

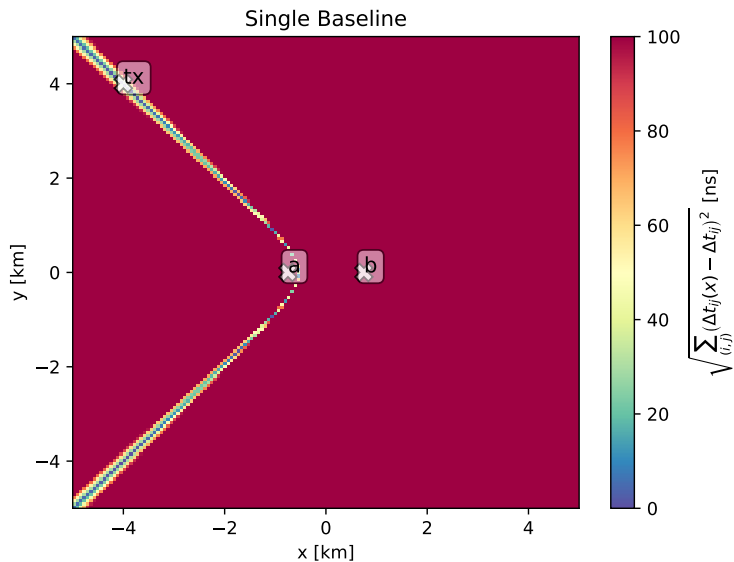

Beacon: Pulse (3 baselines)

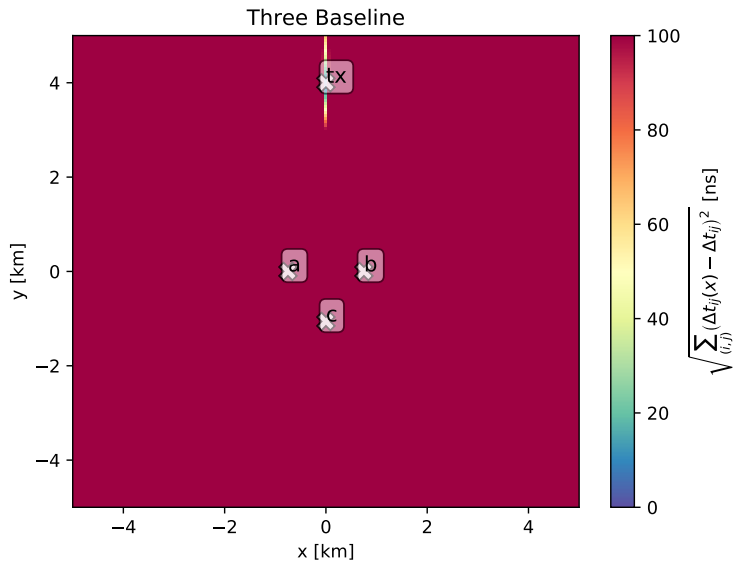

Beacon: Pulse (3 baselines)

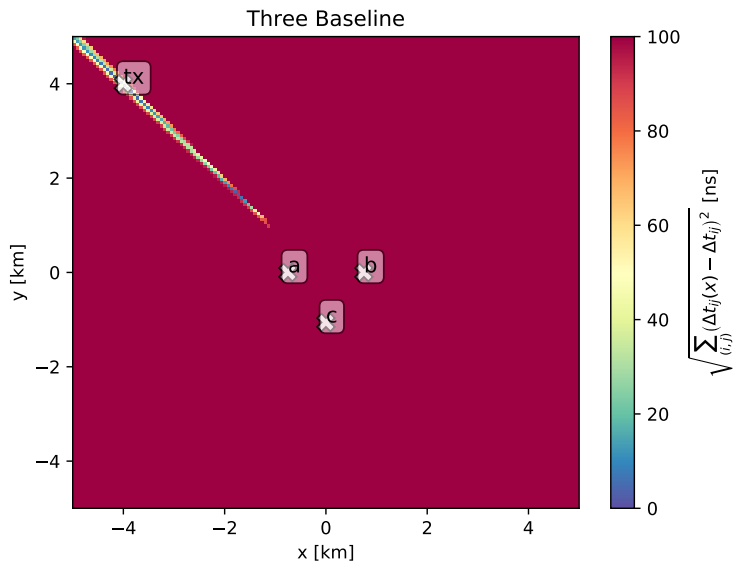

Beacon: Pulse (multi baseline)

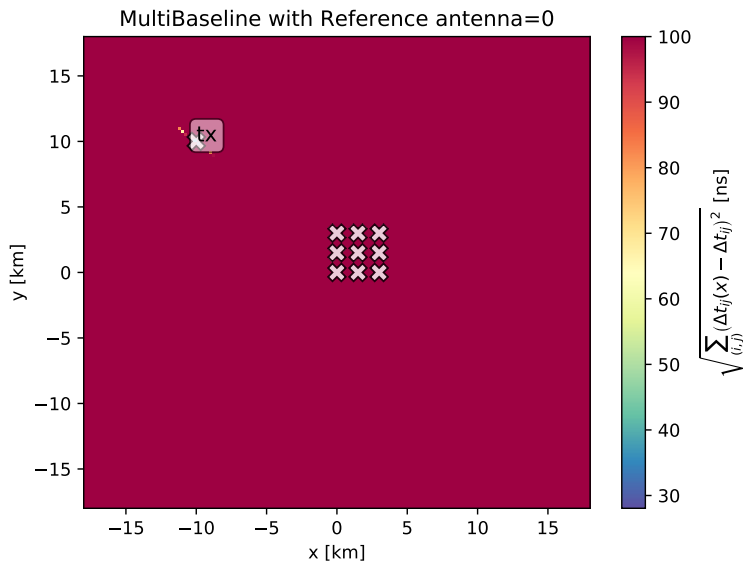

Beacon: Pulse (multi baseline)

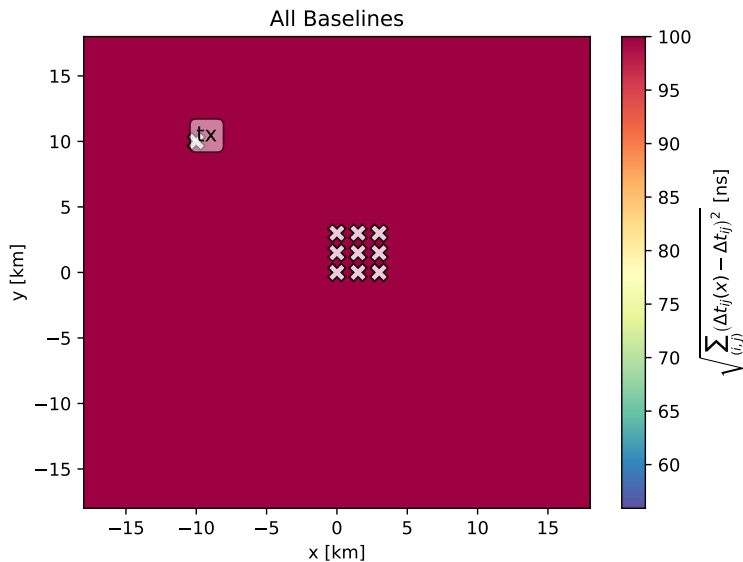

Beacon: Sine (single baseline)

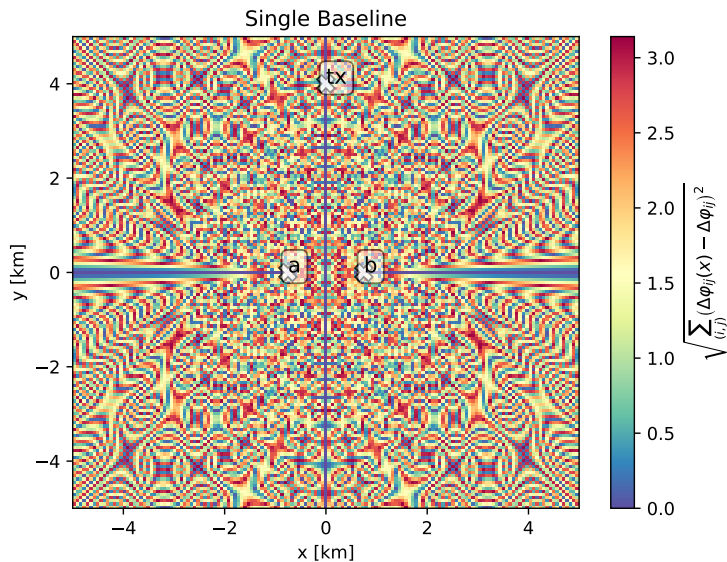

Beacon: Sine (single baseline)

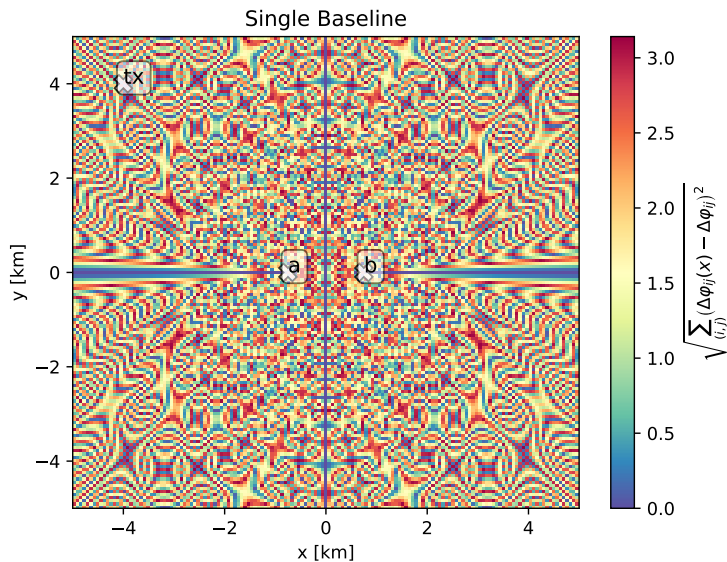

Beacon: Sine (3 baseline)

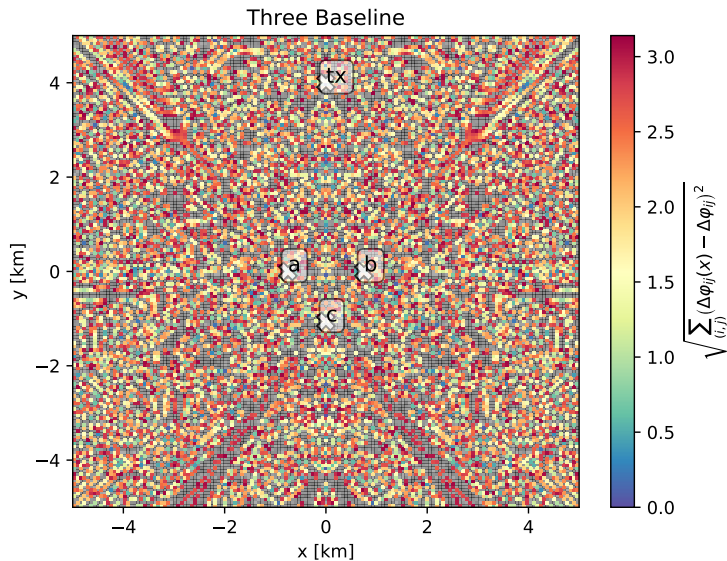

Beacon: Sine (3 baseline)

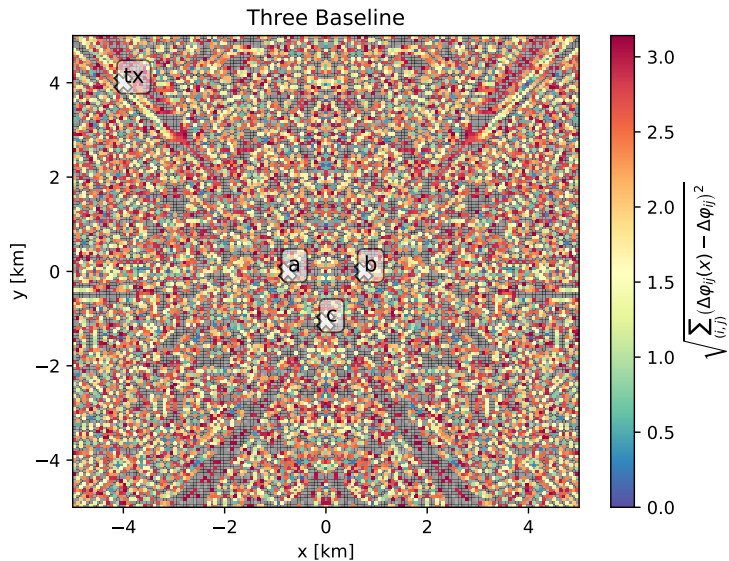

Beacon: Sine (multi baseline reference antenna)

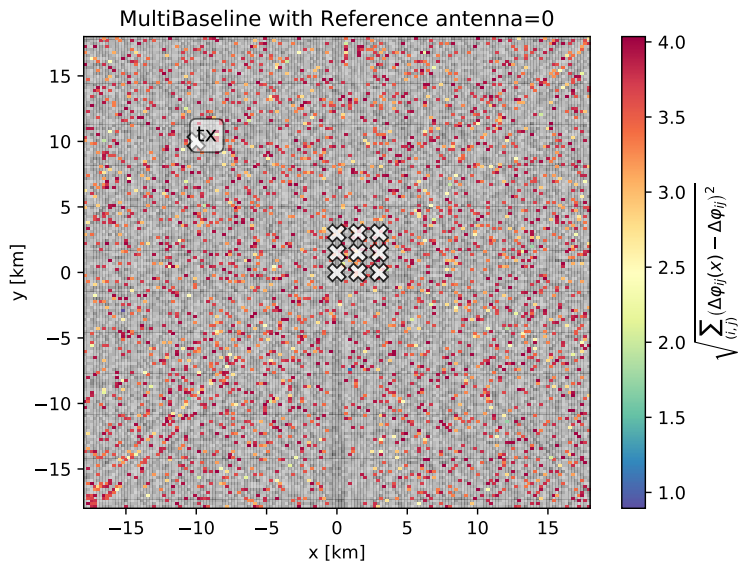

Beacon: Sine (all baselines)

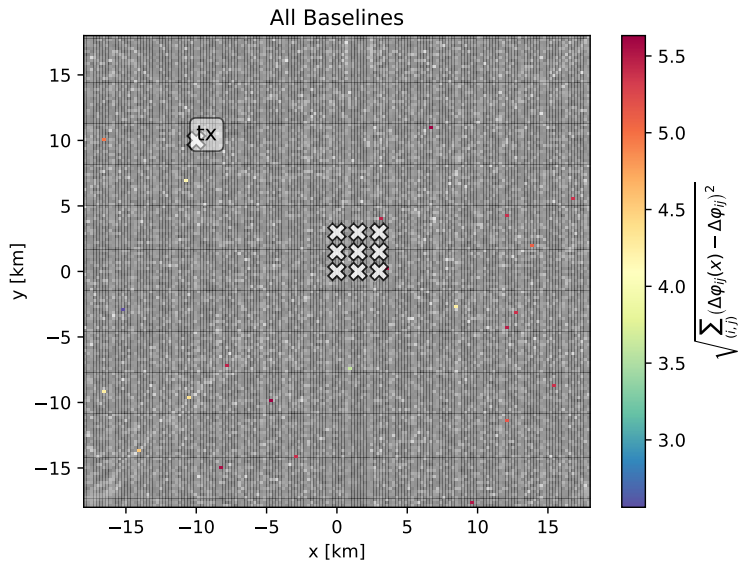

DTFT vs DFT

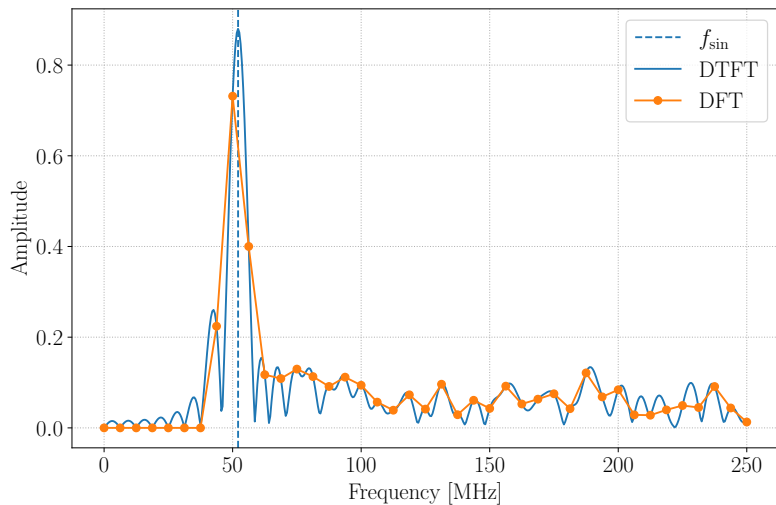

(Discrete) Fourier and Phase

$$u(t) = \exp(i2\pi ft + \phi_t) \xrightarrow{\text{Fourier Transform}} f', \phi_f$$

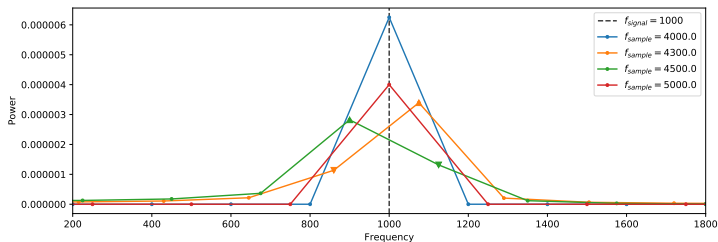

Phase reconstruction?

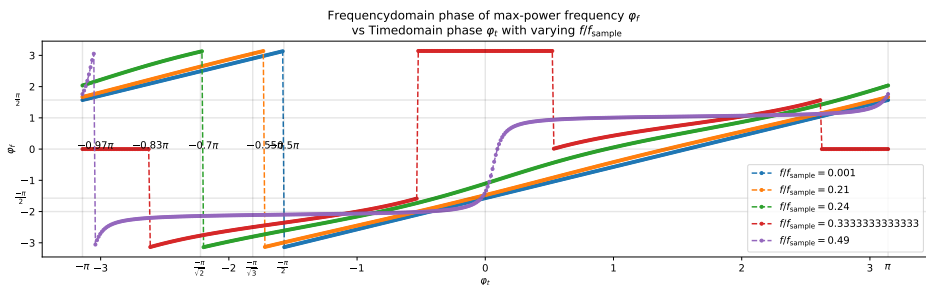

Phase reconstruction is easy if sample rate “correct”

Phase reconstruction?

What if sample rate “incorrect”?

Maximum Power frequencies and their phase

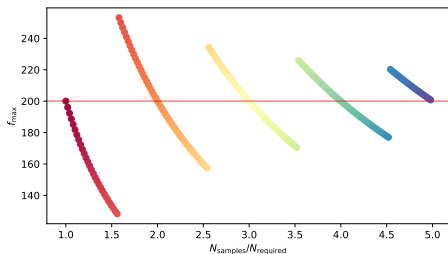
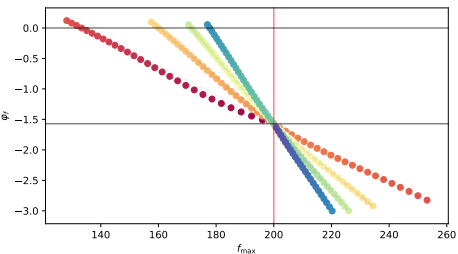

Phase reconstruction?

What if sample rate “incorrect”?

→ Linear interpolation (f_{signal} , f_{max} , f_{submax} , ϕ_{max} and ϕ_{submax})

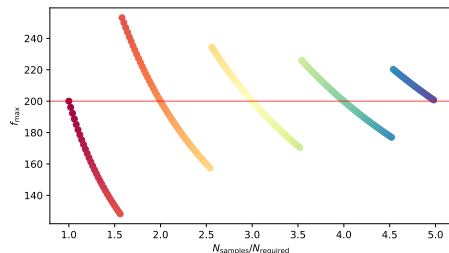
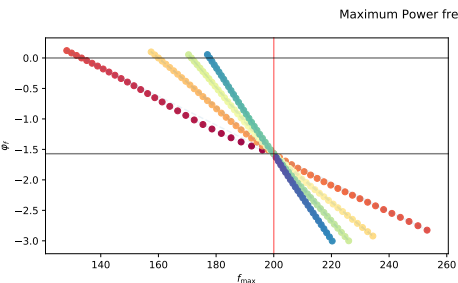

Phase reconstruction?

What if sample rate “incorrect”?

→ Linear interpolation (f_{signal} , f_{max} , f_{submax} , ϕ_{max} and ϕ_{submax})

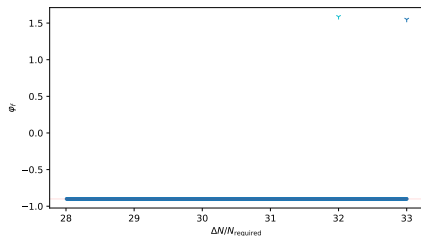
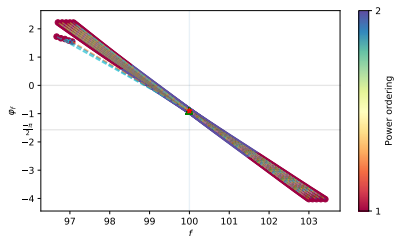

Phase reconstruction?

What if sample rate “incorrect”?

→ Linear interpolation (f_{signal} , f_{max} , f_{submax} , ϕ_{max} and ϕ_{submax})

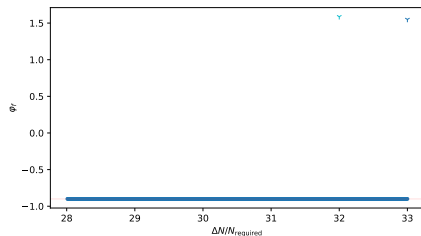
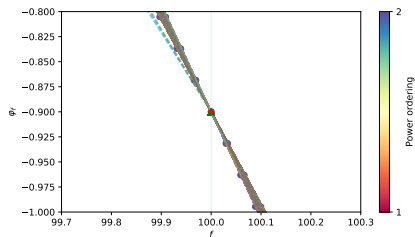

GNSS clock stability I

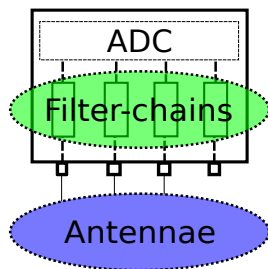

GRAND Digitizer Unit's
ADC to antennae

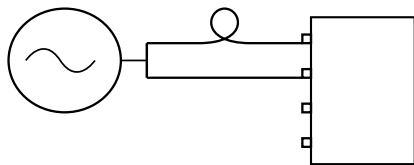

Channel filterchain delay experiment

GNSS filterchain delay experiment

Pulse

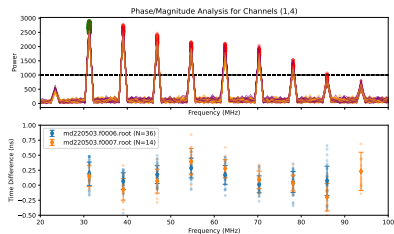

50MHz Sinewave delay(ch1, ch2)
= $46\text{ps} \pm 10$

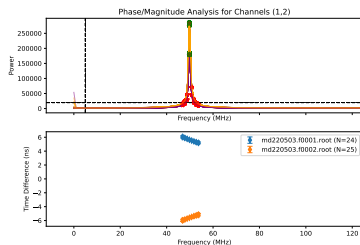

GNSS clock stability II

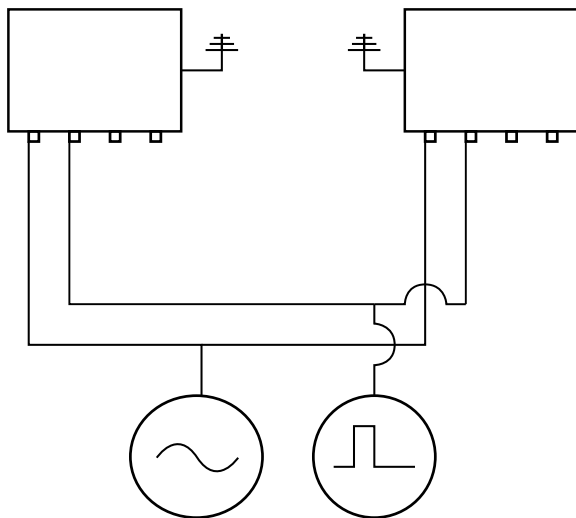

GNSS stability experiment

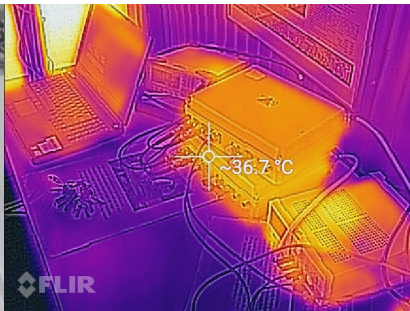
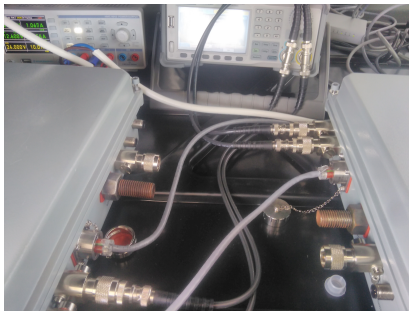
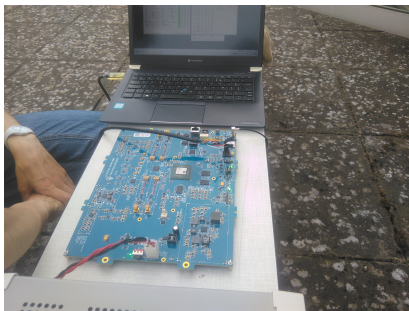

GNSS clock stability III



Precision Time Protocol

- ▶ Time synchronisation over (long) distance between (multiple) nodes

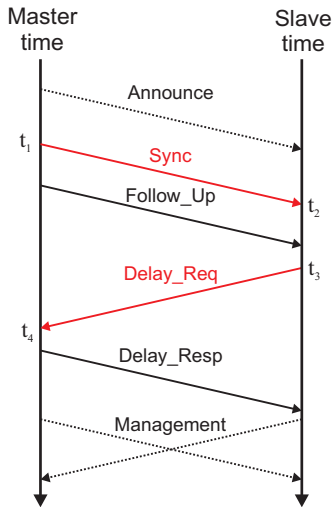

[3] Precision Time Protocol messages.

White Rabbit

White Rabbit:

- ▶ SyncE (common oscillator)
- ▶ PTP (synchronisation)

Factors:

- ▶ device (Δ_{txm} , Δ_{rxs} , ...)
- ▶ link (δ_{ms} , ...)

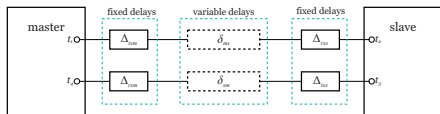

Credit: [3]

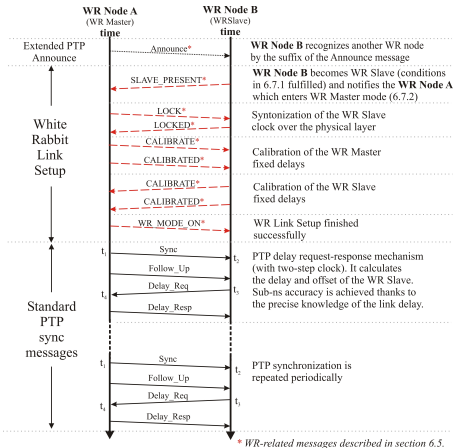

Credit: [3]

White Rabbit Clock Reference

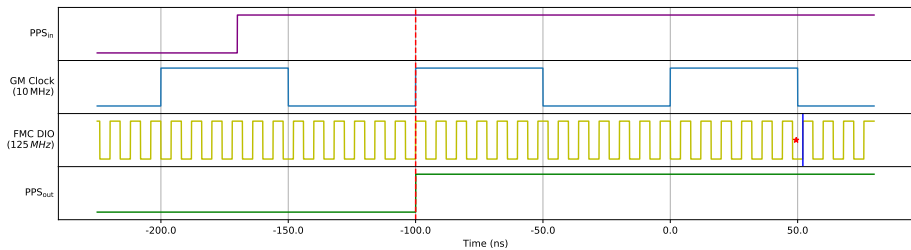

References I

- [1] A. Aab et al. 'Nanosecond-level time synchronization of autonomous radio detector stations for extensive air showers'. In: *JINST* 11.01 (Jan. 2016), P01018. DOI: [10.1088/1748-0221/11/01/P01018](https://doi.org/10.1088/1748-0221/11/01/P01018). arXiv: [1512.02216](https://arxiv.org/abs/1512.02216) [physics.ins-det].
- [2] Jaime Álvarez-Muñiz et al. 'The Giant Radio Array for Neutrino Detection (GRAND): Science and Design'. In: *Sci. China Phys. Mech. Astron.* 63.1 (2020), p. 219501. DOI: [10.1007/s11433-018-9385-7](https://doi.org/10.1007/s11433-018-9385-7). arXiv: [1810.09994](https://arxiv.org/abs/1810.09994) [astro-ph.HE].
- [3] E. Cota et al. *White Rabbit Specification: Draft for Comments*. www.ohwr.org/attachments/1169/WhiteRabbitSpec.v2.0.pdf. July 2011.

References II

- [4] Joseph W. Goodman. 'Statistical Optics'. en. In: 2nd ed. Wiley Series in Pure and Applied Optics. Nashville, TN: John Wiley & Sons, Apr. 2015. Chap. 2.9. ISBN: 978-1-119-00945-0.
- [5] Tim Huege. 'Radio detection of extensive air showers'. In: *Nucl. Instrum. Meth. A* 876 (2017). Ed. by P. Krizan et al., pp. 9–12. DOI: 10.1016/j.nima.2016.12.012. arXiv: 1701.02995 [astro-ph.IM].
- [6] Harm Schoorlemmer et al. 'Radio interferometry applied to the observation of cosmic-ray induced extensive air showers'. In: *Eur. Phys. J. C* 81.12 (2021), p. 1120. DOI: 10.1140/epjc/s10052-021-09925-9. arXiv: 2006.10348 [astro-ph.HE].

References III

- [7] Frank G. Schröder. 'Radio detection of Cosmic-Ray Air Showers and High-Energy Neutrinos'. In: *Prog. Part. Nucl. Phys.* 93 (2017), pp. 1–68. DOI: [10.1016/j.pnpnp.2016.12.002](https://doi.org/10.1016/j.pnpnp.2016.12.002). arXiv: [1607.08781](https://arxiv.org/abs/1607.08781) [astro-ph.IM].